

Ultra High Precision Z-Foil Surface Mount Current Sensing Chip Resistors with TCR of $\pm 0.05 \text{ ppm}/^\circ\text{C}$ and Power Coefficient of 5 ppm at Rated Power

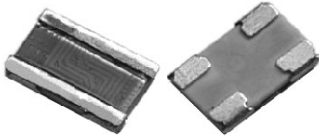

Any value at any tolerance available within resistance range

INTRODUCTION

The Z-foil technology provides a significant reduction of the resistive component's sensitivity to ambient temperature variations (TCR) and applied power changes (PCR). Designers can now guarantee a high degree of stability and accuracy in fixed-resistor applications using solutions based on Vishay's revolutionary Z-foil technology.

Model VCS1625Z is a surface mount chip resistor designed with 4 pads for Kelvin connection. Utilizing Vishay's Bulk Metal® Z-foil as the resistance element, it provides performance capabilities far greater than other resistor technologies can supply in a product of comparable size. 0.05 ppm/°C absolute TCR removes errors due to temperature gradients.

This small device dissipates heat almost entirely through the pads so surface mount users are encouraged to be generous with the board's pads and traces.

Our application engineering department is available to advise and to make recommendations. For non-standard technical requirements and special applications, please contact us.

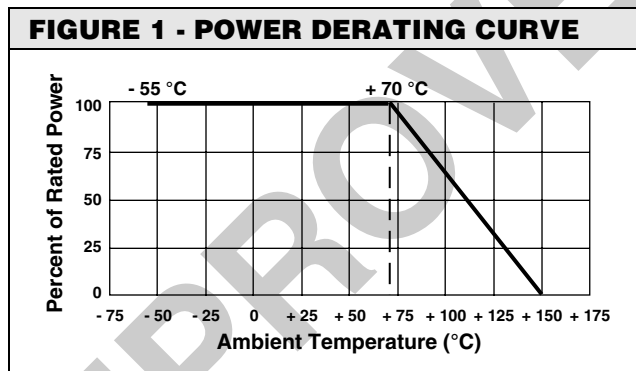

MODEL NUMBER	RESISTANCE RANGE	RESISTANCE TOLERANCE	POWER RATING at +70 °C	TYPICAL TCR and MAX. SPREAD (-55 °C to +125 °C, +25 °C)	MAXIMUM CURRENT
VCS1625Z	> 2.0 Ω to 10 Ω 0.3 Ω to 2.0 Ω	± 0.2 %, ± 0.5 %; ± 1.0 % ± 0.5 %; ± 1.0 %	1 W on alumina substrate (0.5 W on FR4 PCB)	± 0.2 ± 2.8 ppm/°C	5 A

Note

- Tighter performances are available. Please contact application engineering foil@vishay.com

* Pb containing materials are not RoHS compliant, exemptions may apply

FEATURES

- Temperature coefficient of resistance (TCR):
± 0.05 ppm/°C typical (0 °C to + 60 °C)
± 0.2 ppm/°C typical (- 55 °C to + 125 °C, + 25 °C ref.) (see table 1)
- Tolerance: to ± 0.2 %
- Power coefficient "ΔR due to self heating":
5 ppm at rated power
- Load life stability: 0.02 % at 70 °C, 2000 h at rated power
- Electrostatic discharge (ESD) above 25 000 V
- Short time overload < 0.005 %
- Ohmic values: 0.3 Ω to 10 Ω
(for higher or lower values please contact us)
- Power rating: 1 W at + 70 °C (Figure 1)
- Non inductive, non capacitive design
- Rise time: 1 ns without ringing
- Current rating: 5 A maximum
- Current noise: < - 40 dB
- Voltage coefficient: < 0.1 ppm/V
- Non inductive: < 0.08 μH
- Non hot spot design
- Any value available within resistance range (e.g. 1R234)
- Prototype samples available from 48 h. For more information, please contact foil@vishay.com
- For better performances please contact us



RoHS*
COMPLIANT

TERMINATIONS

- Two lead (Pb)-free options are available:
gold plated or tin plated
- Tin/lead plated

APPLICATIONS

- Military
- Medical
- Automatic test equipment (ATE)
- Airborne (in heads-up display systems)
- High precision instrumentation
- Electron beam recording equipment
- Electron microscopes
- Current sensing applications
- Forced balance electronic scales
- Applications that require superior frequency stability

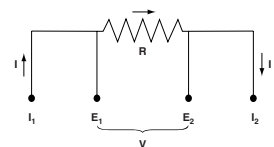

FIGURE 2 - DIMENSIONS in inches (millimeters)

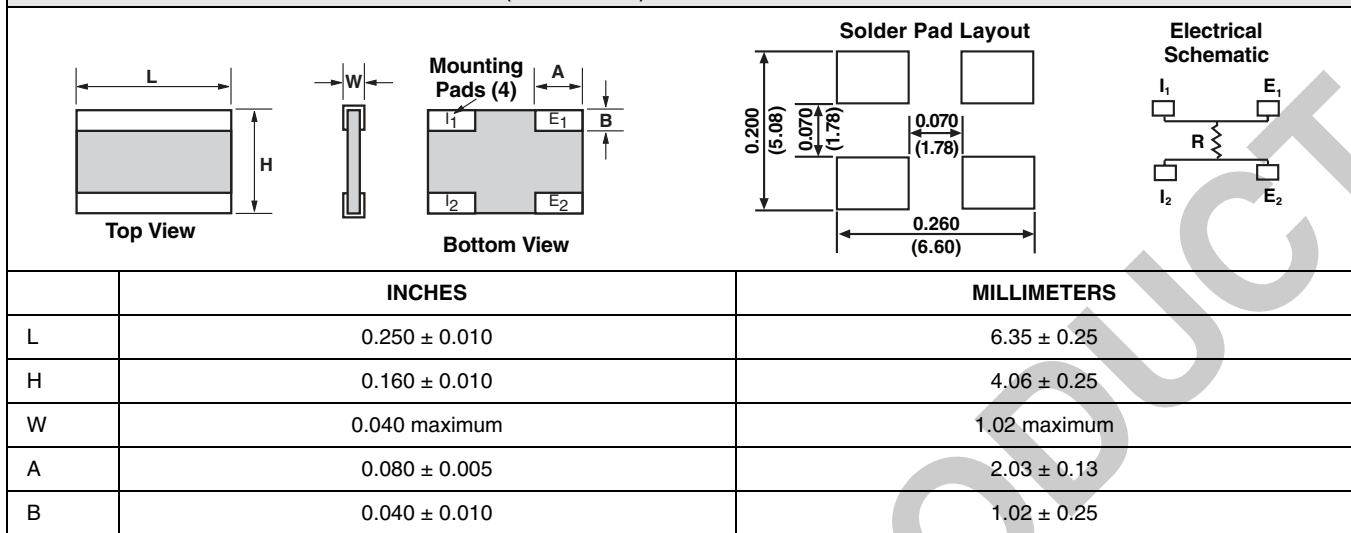

FIGURE 3 - TRIMMING TO VALUES
(Conceptual Illustration)

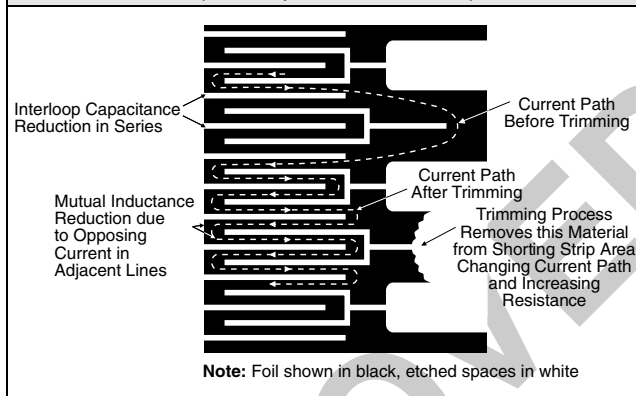

FIGURE 4 - TYPICAL TCR CURVE Z-FOIL

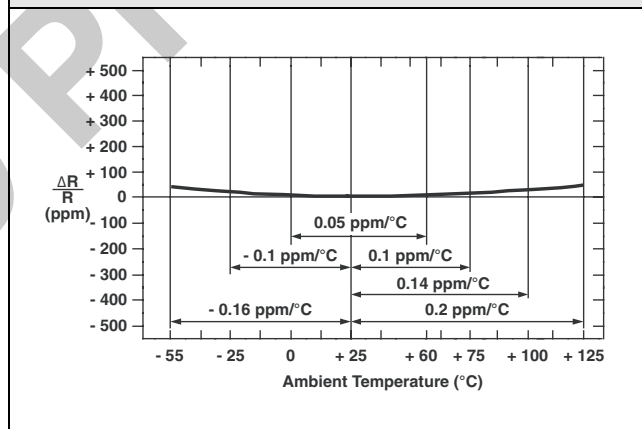

TABLE 2 - PERFORMANCE SPECIFICATIONS

TEST	MIL-PRF-55342 ΔR LIMITS	TYPICAL ΔR LIMITS	MAXIMUM ΔR LIMITS ¹⁾
Thermal shock 5 x (-65 °C to +150 °C)	$\pm 0.10 \%$	$\pm 0.005 \%$ (50 ppm)	$\pm 0.01 \%$ (100 ppm)
Low temperature operation	$\pm 0.10 \%$	$\pm 0.005 \%$ (50 ppm)	$\pm 0.01 \%$ (100 ppm)
Short time overload	$\pm 0.10 \%$	$\pm 0.005 \%$ (50 ppm)	$\pm 0.02 \%$ (200 ppm)
High temperature exposure	$\pm 0.10 \%$	$\pm 0.01 \%$ (100 ppm)	$\pm 0.02 \%$ (200 ppm)
Resistance to soldering heat	$\pm 0.2 \%$	$\pm 0.01 \%$ (100 ppm)	$\pm 0.03 \%$ (300 ppm)
Moisture resistance	$\pm 0.2 \%$	$\pm 0.01 \%$ (100 ppm)	$\pm 0.03 \%$ (300 ppm)
Load life 2000 h at 70 °C: rated power on ceramic PCB	$\pm 0.5 \%$	$\pm 0.02 \%$ (200 ppm)	$\pm 0.04 \%$ (400 ppm)

Note

1. Measurement error 0.001 R



Ultra High Precision Z-Foil Surface Mount Current Sensing Chip Resistors with TCR of $\pm 0.05 \text{ ppm}/^\circ\text{C}$ and Power Coefficient of 5 ppm at Rated Power Vishay Foil Resistors

TABLE 3 - GLOBAL PART NUMBER INFORMATION

NEW GLOBAL PART NUMBER: Y16071R5000D9W (preferred part number format)

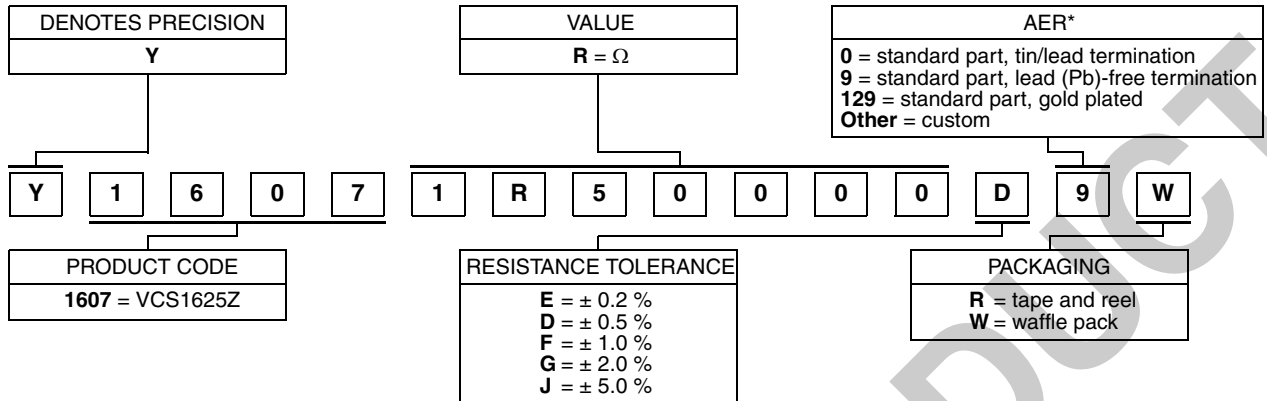

FOR EXAMPLE: ABOVE GLOBAL ORDER Y1607 1R5000 D 9 W:

TYPE: VCS1625Z
 VALUE: 1.5Ω
 ABSOLUTE TOLERANCE: $\pm 0.5\%$
 TERMINATION: lead (Pb)-free
 PACKAGING: waffle pack

HISTORICAL PART NUMBER: VCS1625Z 1R5000 TCR0.2 D S W (will continue to be used)

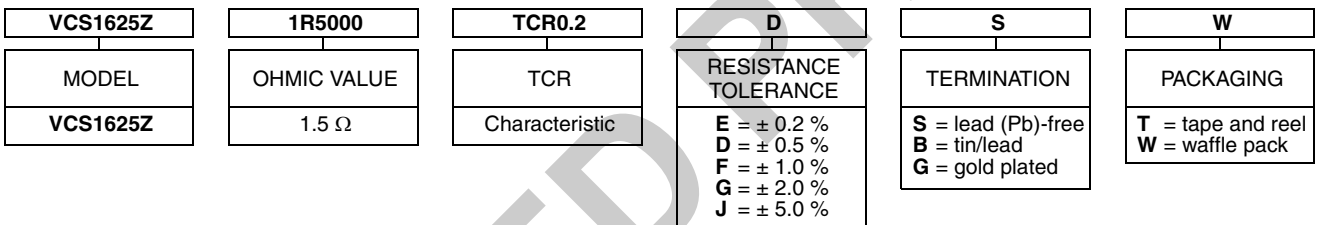

Note

* Application engineering release: for non-standard requests, please contact application engineering.



Disclaimer

All product specifications and data are subject to change without notice.

Vishay Intertechnology, Inc., its affiliates, agents, and employees, and all persons acting on its or their behalf (collectively, "Vishay"), disclaim any and all liability for any errors, inaccuracies or incompleteness contained herein or in any other disclosure relating to any product.

Vishay disclaims any and all liability arising out of the use or application of any product described herein or of any information provided herein to the maximum extent permitted by law. The product specifications do not expand or otherwise modify Vishay's terms and conditions of purchase, including but not limited to the warranty expressed therein, which apply to these products.

No license, express or implied, by estoppel or otherwise, to any intellectual property rights is granted by this document or by any conduct of Vishay.

The products shown herein are not designed for use in medical, life-saving, or life-sustaining applications unless otherwise expressly indicated. Customers using or selling Vishay products not expressly indicated for use in such applications do so entirely at their own risk and agree to fully indemnify Vishay for any damages arising or resulting from such use or sale. Please contact authorized Vishay personnel to obtain written terms and conditions regarding products designed for such applications.

Product names and markings noted herein may be trademarks of their respective owners.